

Wheel-Horse

YARD AND GARDEN TRACTOR

Reg. U. S. Pat. Off.

INSTRUCTION MANUAL AND PARTS LIST

Model RJ-58-59

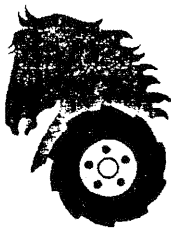

WHEEL-HORSE PRODUCTS

SOUTH BEND, INDIANA

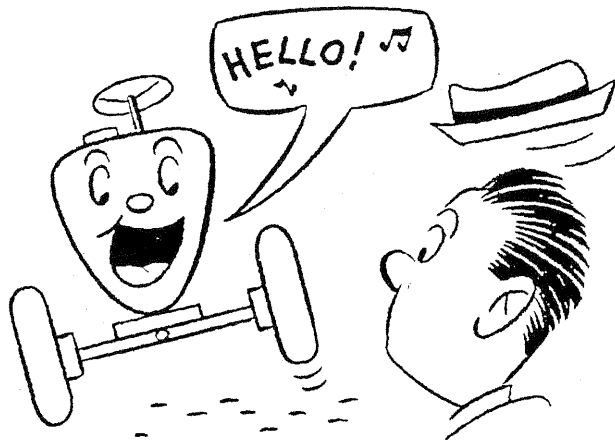

I am speaking directly to you because my builders, Wheel Horse Products, Inc., felt that the information you'll need to operate and maintain me should come straight from the Wheel Horse's mouth. (Their sense of humor is not so hot, but they sure do turn out a mighty fine tractor . . . me, that is.)

Many thanks for choosing me. I'm flattered. I assure you that my strength, dependability and versatility will let you tackle any rough, tough job around your grounds.

One thing we "gotta" get settled right off the bat. I can't feed myself so it's up to you to supply the petroleum products I require. Actually, I need very little attention, and if you provide food, shelter and doctor's care, I'll work long hours each day for many years to come.

A WHEEL-HORSE IS BORN!

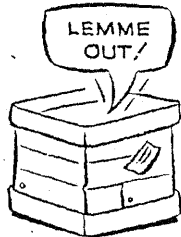

To protect me during shipment, I arrived at your dealer's store neatly and completely packed into one sturdy shipping carton. Your dealer has probably assembled me for you. If not, I am very easy to set up. Following is a check list of my

parts included in the carton unassembled (to make a smaller and more compact shipping package), which must be installed in their proper places:

2 Rear Wheels	2 3/4" Snap Ring (No. 1127)
2 Front Wheels	1 1/4" "U" Bolt (No. 1240)
1 Muffler, Exhaust	1 1/2 x 1 Carriage Bolt (No. 1106)
1 Exhaust Pipe	1 3/16 x 1 3/4 Roll Pin (No. 1127)
1 Exhaust Pipe, 45° elbow	1 Clevis Pin (No. 1235)
1 Lift Hitch with pin	6 Wheel Bolts (No. 1004)
1 Steering Wheel (under the seat)	

Bolt on the rear wheels with my tire treads pointing forward on top, my rims dished out and my valves on the inside, with 6 wheel bolts provided. Arrows on the side of my tires point the proper forward direction

of rotation. Slip on my two front wheels and secure with the snap-rings provided.

My steering wheel has been bolted under the seat. Remove the shipping bolt and remove the steering wheel. Now bolt my seat—gently sir—to the seat spring with the carriage bolt provided, in either the forward or the rear hole of my seat spring, depending on the length of your legs. Fasten my steering wheel to the steering column with the roll-pin provided. Install my draw bar hitch behind my transmission and between cover plates with the pin provided. (See exploded view.) Connect the rear end of my lift cable to my draw bar hitch with the clevis pin provided. Screw the muffler pipe into position and secure with the 1/4" "U" bolt provided. (See exploded view.) Screw on 45° elbow and exhaust muffler, so that I can blow my breath (exhaust gases) out from under my hood, 45° from straight forward.

LET'S GET OILED!

Important: There is **no oil** in the crank case of my engine when shipped from the factory. Before starting my engine be sure to fill my crank case and air-cleaner to the level indicated with the recommended lubricant, specified in the engine manual. Further instructions pertaining to my engine, its care and lubrication are contained in the engine manual.

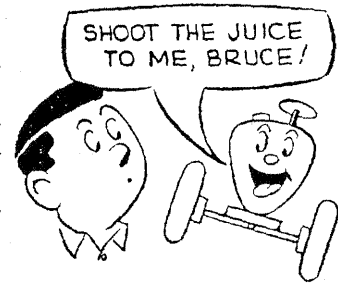

You had better read these instructions carefully, Boss!

To insure a longer useful life for me, remember that I require the same type of proper lubrication as the family automobile. Refer to the exploded view for the location of my seven high-pressure grease fittings, and

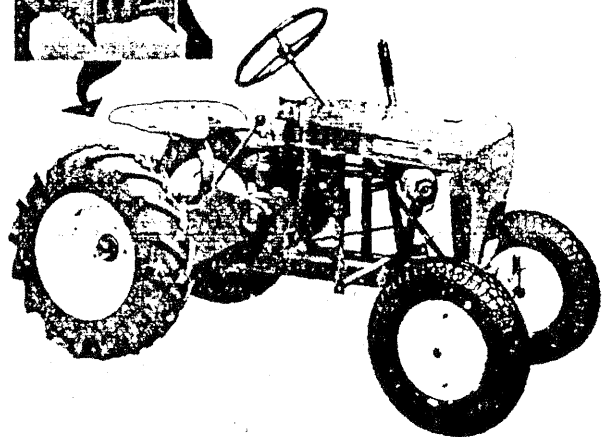
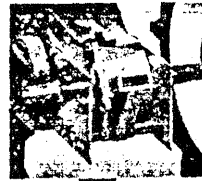

lubricate each grease fitting with regular pressure gun lubricant approximately every eight to ten hours of operation. Lubricate all the rest of my working parts periodically with light oil to keep my joints from squeaking. You don't want me to get arthritis! My automotive-type sliding gear transmission, reduction gears and differential fit compactly into one oil-tight case and all of my gears operate in an oil bath. Oil was put into my transmission at the factory before it was tested under power in all four working gears and this oil was not removed. However, **do not** attempt to operate me without at least checking the oil level in my transmission. Loss of oil might occur due to improper handling in shipping.

Check the oil-level in my transmission by removing my oil check-plug, located on the right side of the transmission just below the axle, making sure that the oil is up to this level. If necessary, remove filler plug (located on top of the transmission) and add S.A.E. No. 90 Gear Lube. Check oil level after each 25 hours of operation.

My belt-idler is a grease sealed ball-bearing and requires no further lubrication. My front tires have been filled with liquid anti-freeze ballast at the factory to provide additional weight in my front end. **Do not** check the pressure of my front wheels as the ballast contained in the tires is harmful to the ordinary air-gauge, and some ballast will be lost in the process. My rear tires should be inflated to six to eight pounds of air-pressure. My rear tires can also be filled with a liquid ballast. But this is not ordinarily necessary as the weight of the operator adds sufficient weight on the rear tires for adequate traction.

ALL ABOARD!

If you are sure my engine and my chassis have been properly serviced I am ready to go to work. Refer to your Engine Instruction Manual for starting and running my engine. Before starting my engine, make sure the gear shift lever is in the **neutral position**. Flip my "On-Off" switch to the "on" position, open throttle about half-way and choke if the engine is cold before pulling the engine over with my retractable starter.

To stop the engine, simply flip my "On-Off" switch to the "off" position. To start me in motion depress my clutch pedal (located on the left side) and select the desired speed range, (first, second, third or reverse) by manipulating my shift stick to the proper position as shown by the shift instructions printed on the rear of the hood. My gear shift lever is located just forward of my seat. **Do not** force my shift lever if gears do not immediately mesh. (Quickly throw clutch in and out, then shift gears again.) Release my clutch slowly and smoothly to avoid jerky starts. (I don't want to be a jerk!) Do not shift my gears while I am in motion without depressing my clutch. When you depress my clutch pedal, my belt-idler is released from my belt, so that my belt cannot drive. When my clutch pedal is released, spring

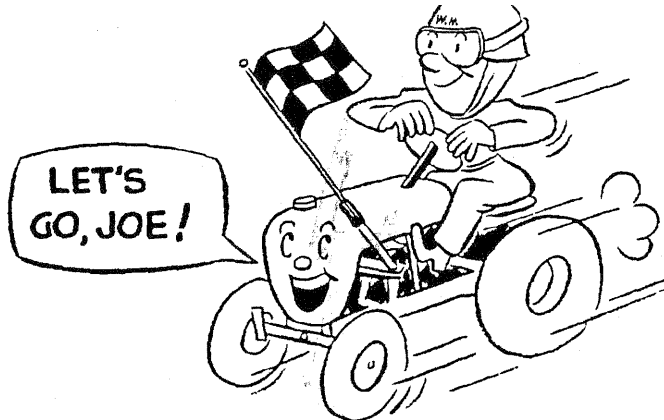

tension forces my belt idler down on my belt with the correct amount of belt tension always being maintained. I am unique in that my clutch pedal also operates my brakes when it is depressed all the way. My brake band, located on the left side of my transmission, brakes the transmission, which in turn brakes both wheels. Adjust the nuts on my brake rod so that, when you depress my clutch pedal, my brake band tightens around my brake drum, just before my idler pulley hits the top of my belt guard. This clutch-brake pedal combination makes it very simple to shift gears on a hillside without clashing gears.

It is not necessary to use my brakes while going down a hill, unless you wish to come to a complete stop, because my gear train will hold me back and keep me from running away down the hill. When leaving me parked on unlevel ground, leave my gear shift lever in the low-gear position. This will act as an emergency brake to keep me from rolling away.

Give me the same care that you give your automobile and please, don't abuse me by improper handling. Keep me sheltered from the weather when not in use, and it's a good idea to visit your Wheel Horse dealer from time to time, and have him give me a thorough checkup for longer tractor life and better performance.

Sincerely yours,

Wheel-Horse

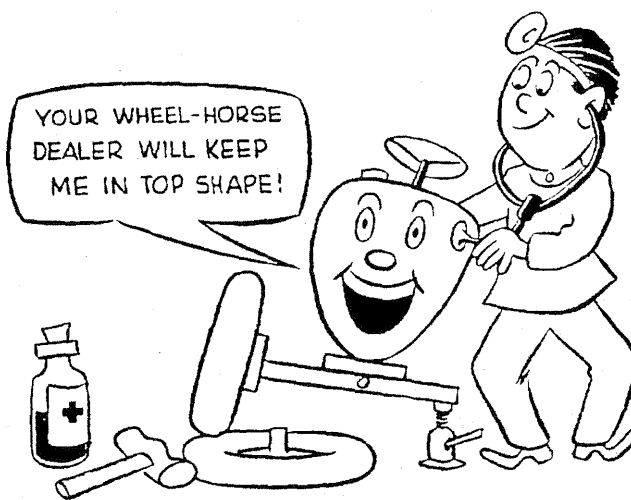

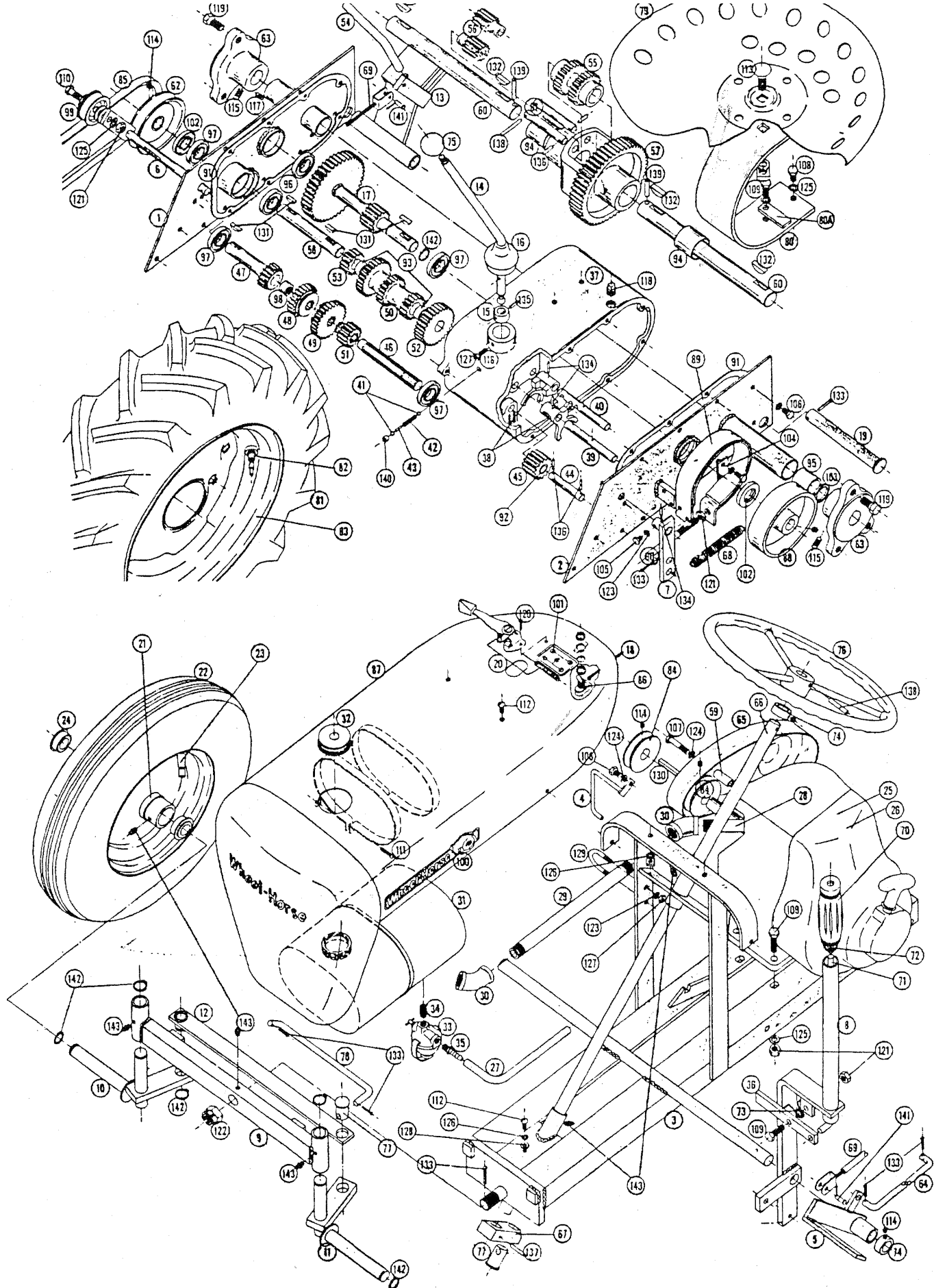

PARTS LIST

Ref. Part No.	Part No.	Description	No. Req.	Ref. Part No.	Part No.	Description	No. Req.
1	3504	Right Transmission Cover	1	71	3468	Plunger Rod	1
2	3509	Left Transmission Cover	1	72	3578	Guide, Plunger	1
3	3546	Frame	1	73	1035-L	Torsion Spring	1
4	3579	Belt Guard, Attachment 5617	1	74	1085	Shaft Collar	2
5	3567	Clutch Pedal	1	75	1001	Knob	1
6	3552	Idler Arm	1	76	3415	Steering Wheel 101521	1
7	3556	Clutch Arm	1	77	3461	Clevis Pin, Steering	2
8	3410	Tool Lift Lever	1	78	3441	Steering Link	1
9	3435	Front End	1	79	2510	Seat 3973	1
10	3401	Front Spindle, (Right)	1	80	3537	Seat Spring	1
11	3400	Front Spindle, (Left)	1	80-A	3583	Lug, Cable-Clamping	1
12	3456	Tie Rod	1	81	1650	Tire with Tube, 6 x 12	2
13	3560	Hitch, Draw Bar	1	82	1654	Tube, Inner	2
14	3538	Lever, Shift 5278	1	83	1700	Rim	2
15	3514	Collar, Shift Lever	1	84	1608	Pulley, Engine	2
16	3577	Boot, Shift Lever	1	85	1567	Belt	1
17	3559	Brake Shaft and Gear	1	86	3279	Stop Switch	1
18	1146	Wire, Remote Stop	1	87	1869	Hood with Straps	1
19	3572	Pin, Draw Bar Hitch	1	88	3540	Brake Drum	1
20	1782	Throttle Control Assembly	1	89	3543	Brake Band with Liner	1
21	1712	Wheel, Front	2	90	3545	Brake Rod	1
22	1656	Tire, Front, 4:00 x 8	2	91	3536	Gasket, Transmission	2
23	1657	Tube, Front, 4:00 x 8 1669	2	92	1516	Bronze Bearing, 1/2x5/8x1 1/8	1
24	1514	Ball Bearing 108483	4	93	1504	Bronze Bearing, 3/4x7/8x3/4	2
	1521	Sintered Iron Bearing	4	94	1517	Bronze Bearing, 1 3/8x1 1/2x1-7/16	2
	1709	Front Tire and Wheel Assembly 1112	2	95	1503	Bronze Bearing, 1x1 1/8x1 1/2	2
25	1781	Engine, Clinton	1	96	1502	Ball Bearing, 3/4x1 3/8x3/8	3
26	1779	Engine, Kohler	1	97	1519	Ball Bearing (Ground), 3/4x1 3/8x5/16	4
27	1790	Fuel Line	1	98	1518	Needle Bearing	1
28	1158	Nipple, Pipe, 1/2 x 3/2 (Clinton only)	1	99	3542	Idler Pulley	1
	3487	Nipple, Pipe, 3/4 Close (Kohler)	1	100	1228	Cromcol "Wheel Horse"	2
29	1159	Nipple, Pipe, 1/2 x 1 1/2 (Clinton only)	1	101	3541	Cromcol "Shift Instructions" 7883	1
	3488	Nipple, Pipe, 3/4 x 1 1/2 (Kohler only)	1	102	1234	Oil Seal	2
30	1160	45° Elbow x 1/2 (Clinton only)	2	103	1257	Oil Seal (Axle)	2
	3489	90° Elbow x 3/4 (Kohler only)	1	104	3582	Spring Anchor	1
	3490	45° Elbow x 3/4 (Kohler only) 943045	1	105	1237	Cap Screw, Hex Head, 1/4-20x3/8	2
31	1785	Fuel Tank with cap 2476	1	106	1238	Cap Screw, Hex Head, 5/16-18x3/8	19
32	1789	Cap, Fuel Tank 108011	1	107	1092	Cap Screw, Hex Head, 5/16x18x1 3/4	2
33	1786	Strainer	1	108	1062	Cap Screw, Hex Head, 3/8-16x1	7
34	1192	Nipple, Close	1	109	1028	Cap Screw, Hex Head, 3/8-16x1 1/4	6
35	1787	Connector, Straight Gas Line 105076	1	110	1064	Cap Screw, Hex Head, 3/8-16x1 1/2	1
36	3467	Lock Bar, Lift Lever	1	111	1003	Stove Bolt, Slotted, R.D., 3/16x1	2
37	3501	Transmission Housing	1	112	1143	Stove Bolt, Slotted, R.D., 1/4x3/8	5
38	3503	Shift Fork	2	113	1106	Carriage Bolt, 1/2-13x1	1
39	3515	Shift Rail, Front 5615	1	114	1042	Set Screw, Socket Hd. Cup Point, 5/16-18x5/16	2
40	3516	Shift Rail, Rear 5616	1	115	1161	Set Screw, Cup Point, 3/8-16x5/8	2
41	3517	Ball, Stop	2	116	1239	Set Screw, Full Dog Point, 1/4-20x3/4	1
42	3518	Spring, Shift Stop 106030	1	117	1108	Pipe Plug, 1/4"	1
43	3573	Pin, Shift Stop 5614	1	118	1013	Pipe Plug, 1/4" 943419	1
44	3519	Rev. Idler Pin	1	119	1004	Wheel Bolts, Taper Head, 7/16-20x3/4	6
45	3520	Rev. Idler Gear, with Bearing	1	120	1150	Sheet Metal Screw, No. 7x1/2	2
46	3521	Spline Shaft	1	121	1016	Nut, Hex, NC, 3/8-16	14
47	3522	Input Gear	1	122	1010	Nut, Hex, Castle NF, 3/4-16	1
48	3523	Hi and Second Gear	1	123	1113	Lockwasher, Spring, 1/4"	9
49	3524	Low and Reverse Gear	1	124	1045	Lockwasher, Spring, 5/16"	2
50	3525	Cluster Gear 7269	1	125	1039	Lockwasher, Spring, 3/8"	12
51	3526	Splined Pinion	1	126	1067	Lockwasher, External Shakeproof, 1/4"	5
52	3527	Cluster Shaft Reduction Gear	1	127	1034	Nut, Hex, 1/4-20, 915111	3
53	3528	Cluster Shaft Reduction Pinion	1	128	1119	Flat Washer, SAE, 1/4"	1
54	1813	Tool Pin	1	129	1240	U Bolt with nuts, 1/4x1-1/16x1 3/4	1
55	3530	Axle Gear, Differential	2	130	1120	Key, Square, 3/16 Sq. x 2	1
56	3531	Spider Gear, Differential	4	131	1122	Key, Woodruff, No. 9 957014	4
57	3502	Differential Case and Gear 7243	1	132	1008	Key, Woodruff, No. 15	4
58	3533	Cluster Shaft	1	133	1002	Cotter Pin, 1/4x1	8
59	3575	Spacer, Belt Guard	2	134	1244	Roll Pin, 1/4x1	3
60	3532	Axle 3519	2	135	1242	Roll Pin, 5/32x13/16	1
61	3535	Differential Pins 3519	4	136	1133	Roll Pin, 3/16x1 933188	6
62	1611	Pulley, Transmission	1	137	1134	Roll Pin, 3/16x1 1/4	1
63	3513	Wheel Hub 105762	2	138	1227	Roll Pin, 3/16x1 3/4	3
64	3550	Clutch Rod	1	139	1081	Roll Pin, 1/4x1 1/2	2
65	3549	Belt Guard, Transmission	1	140	1243	Cup, Plug, 5/16"	1
66	3438	Steering Rod	1	141	1235	Yoke Pin, 1/4x51/64" 932120	2
67	3409	Steering Lug	1	142	1127	Snap Ring, 3/4" 936125	7
68	1014	Tension Spring	1	143	1030	Grease Fitting, 1/4-28	5
69	3539	Lift Cable	1				
70	1000	Rubber Grip 6542	1				

**CHOOSE FROM 22
optional attachments...**

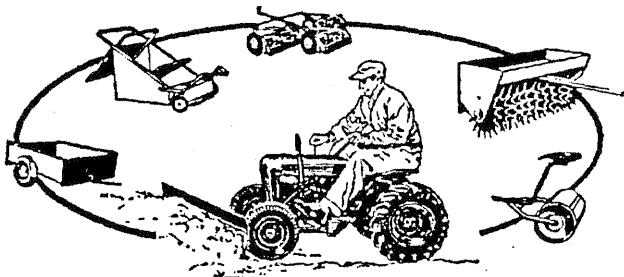

**With a Wheel-Horse
yard and garden tractor**

Fun-work with Wheel-Horse the year 'round... mowing lawns, plowing snow, hauling fill or compost. Only Wheel-Horse has automotive gearing, steering and 2-wheel brakes. Power and traction to spare even on sloping ground.

GUARANTEE

The Wheel-Horse is guaranteed for ninety days from date of purchase against defective parts or workmanship. We will replace, free of charge, any defective part, except in the engine, if returned to the factory prepaid. The engine carries a separate guarantee by the engine manufacturer.

WHEEL-HORSE PRODUCTS

SOUTH BEND, INDIANA